

STONE

Baldanzi & Novelli Design



TECHNICAL FEATURES SPECIFICHE TECNICHE

Multilayer beechwood inner structure, high density foam padding. Polypropylene feet.

Struttura interna in multistrato di faggio, imbottitura in poliuretano espanso indeformabile. Piedini in polipropilene

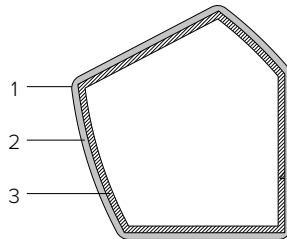

- 1 Upholstery
Rivestimento
- 2 High resistance foam
Poliuretano espanso indeformabile
- 3 Wood inner frame
Struttura interna in legno

SIDE VIEW VISTA LATERALE

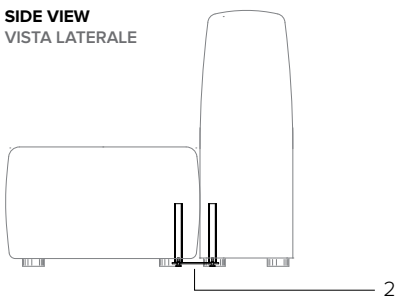

JUNCTION DETAILS DETTAGLIO AGGANCIAMENTO

- 1 Junction channels
Corsia di aggancio
- 2 Junction element
Elemento di aggancio

BOTTOM VIEW VISTA DAL BASSO

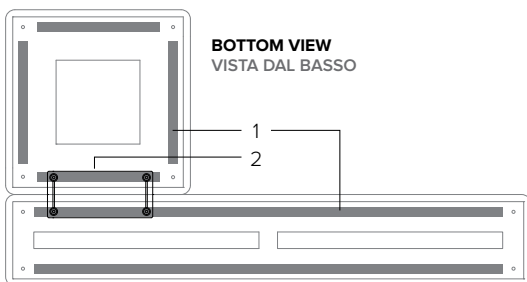

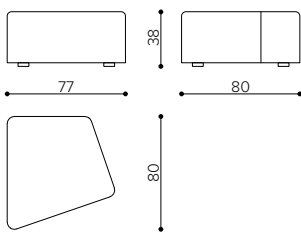
ST A00Rright module A
modulo A destro

m 1,7 ✂ mq 3,4 📦 kg 16 📏 mc 0,26

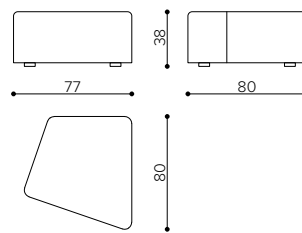
ST A00Lleft module A
modulo A sinistro

m 1,7 ✂ mq 3,4 📦 kg 16 📏 mc 0,26

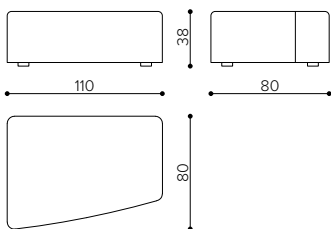
ST B00Rright module B
modulo B destro

m 2,35 ✂ mq 4,7 📦 kg 24 📏 mc 0,36

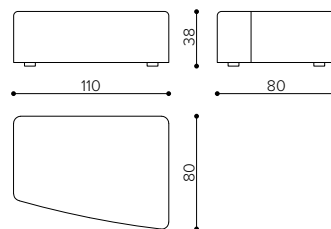
ST B00Lleft module B
modulo B sinistro

m 2,35 ✂ mq 4,7 📦 kg 24 📏 mc 0,36

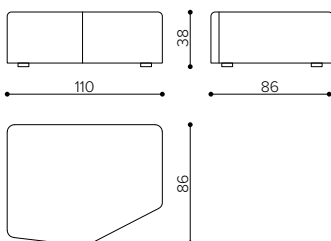
ST C00Rright module C
modulo C destro

m 2,6 ✂ mq 5,2 📦 kg 26 📏 mc 0,4

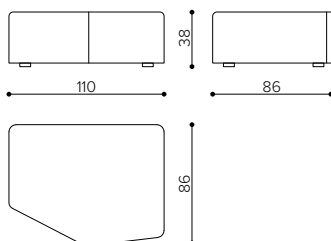
ST C00Lleft module C
modulo C sinistro

m 2,6 ✂ mq 5,2 📦 kg 26 📏 mc 0,4

ST D00R
right module D
modulo D destro

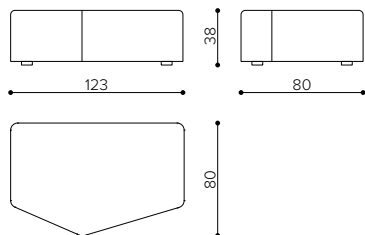

m 2,8 ✨ mq 5,6 📦 kg 25 🛠 mc 0,4

ST D00L
left module D
modulo D sinistro

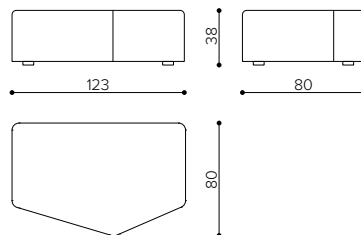

m 2,8 ✨ mq 5,6 📦 kg 25 🛠 mc 0,4

ST E000
square pouf
pouf quadrato

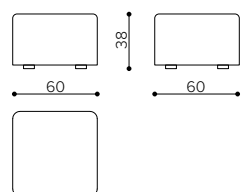

m 1,35 ✨ mq 2,7 📦 kg 14 🛠 mc 0,15

ST F000
backrest
schienale

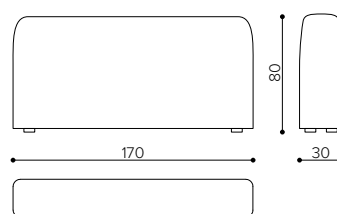

m 3,55 ✨ mq 7 📦 kg 35 🛠 mc 0,45

ST 100R
right pouf
pouf destro

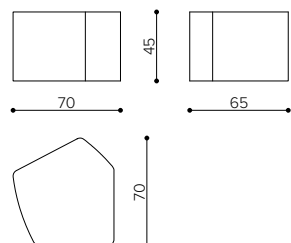

m 1,65 ✨ mq 2,9 📦 kg 16 🛠 mc 0,2

ST 100L
left pouf
pouf sinistro

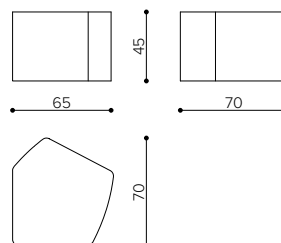

m 1,65 ✨ mq 2,9 📦 kg 16 🛠 mc 0,2

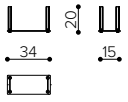

ST JJ00
Junction element
Elemento di collegamento

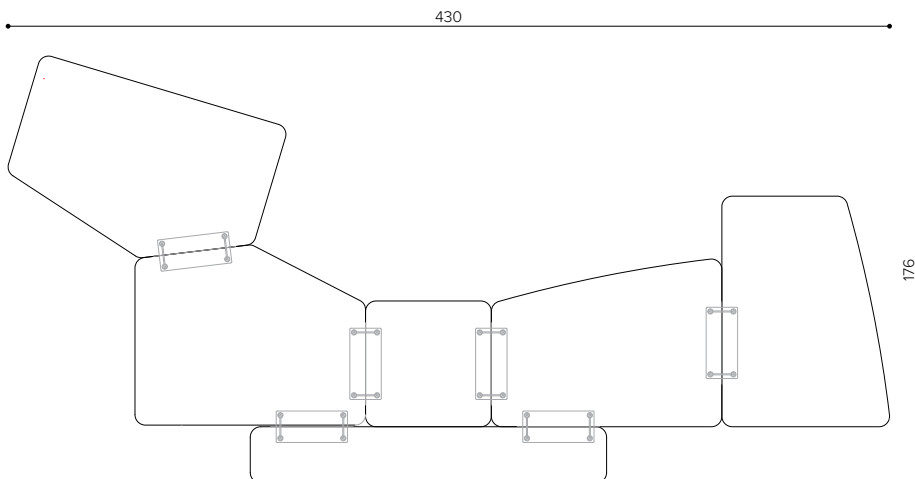
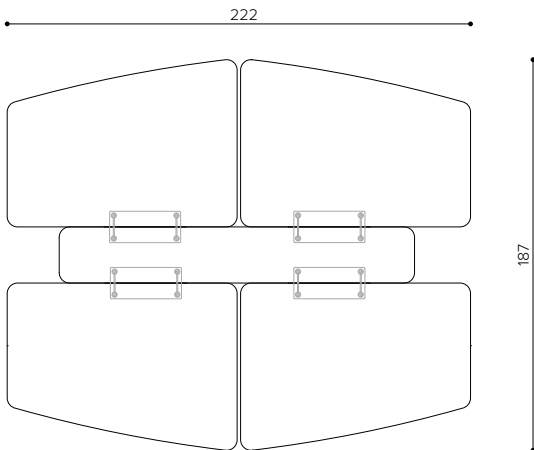
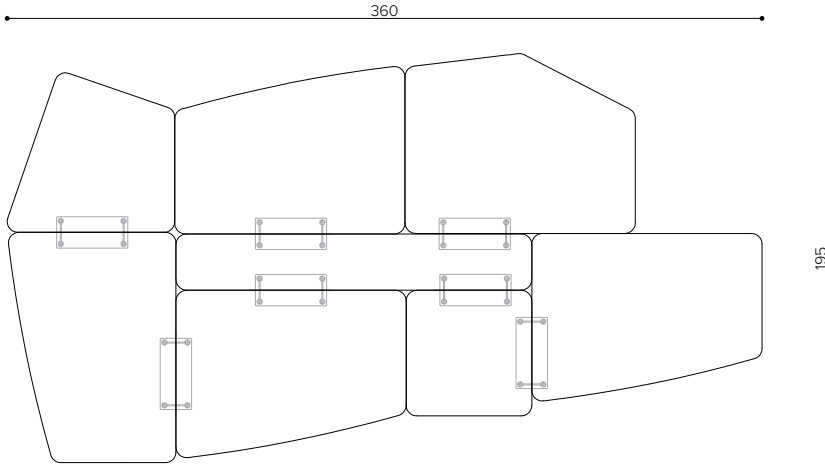

true