

MILLEPIEDI

Parisotto + Formenton



TECHNICAL FEATURES SPECIFICHE TECNICHE

Steel beam frame, powder coated, with laser cut legs; main structure of seat and backrest in multilayer beechwood, with natural oakwood veneer; padded in polyurethane high density foam, upholstered with fabric and leather.

Telaio a trave in acciaio verniciato con gambe tagliate a laser; struttura portante di sedile e schienale in multistrato di faggio con finitura rovere naturale; imbottitura in poliuretano espanso ad alta densità, e rivestimento in tessuto o pelle.

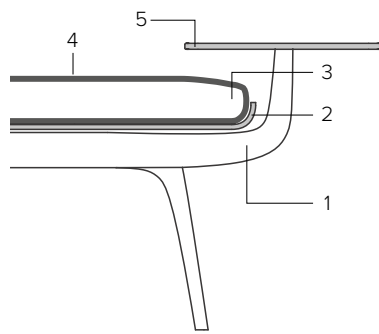

- 1 Steel frame
Telaio in acciaio
- 2 Wooden seating support
Supporto seduta in legno
- 3 Polyurethane foam
Poliuretano espanso
- 4 Upholstery
Rivestimento
- 5 Wooden table
Tavolino in legno

COLORS AND MATERIALS COLORI E MATERIALI

WOOD / LEGNO



Standard finishing for wood is natural oakwood. Customized RAL or PANTONE colors are available upon request.

La finitura standard del legno è il rovere naturale. Su richiesta sono disponibili colorazioni customizzate su tinta RAL o PANTONE.

STEEL / ACCIAIO



The standard finishings for the steel bases are the RAL shown above. Customized RAL/PANTONE colors are available upon request.

Le finiture standard delle basi in acciaio sono i RAL qui mostrati. Su richiesta sono disponibili colorazioni customizzate su altre tinte RAL/PANTONE.

MP 2000 2 seater bench panca 2 posti

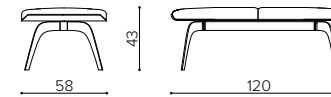

m 1,4 ☆ mq 2,7 📦 kg 25 📏 mc 0,3

MP 3000 3 seater bench panca 3 posti

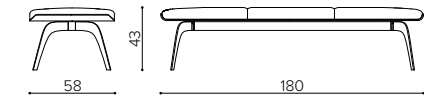

m 1,6 ☆ mq 2,8 📦 kg 35 📏 mc 0,45

MP 2L00 side 2 seater bench panca 2 posti terminale

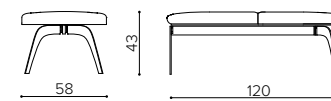

m 1,4 ☆ mq 2,7 📦 kg 20 📏 mc 0,3

MP 3L00 side 3 seater bench panca 3 posti terminale

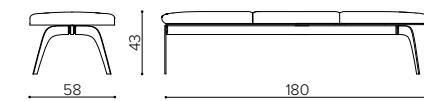

m 1,6 ☆ mq 2,8 📦 kg 30 📏 mc 0,45

MP 2C00 central 2 seater bench panca 2 posti centrale

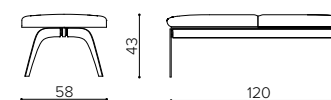

m 1,4 ☆ mq 2,7 📦 kg 20 📏 mc 0,3

MP 3C00 central 3 seater bench panca 3 posti centrale

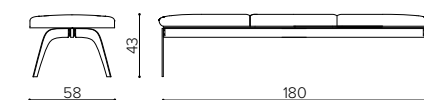

m 1,6 ☆ mq 2,8 📦 kg 30 📏 mc 0,45

MP SR00
right "S" element
elemento "S" destro

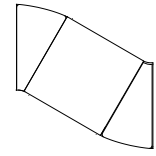
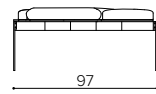

m 1,5 mq 2,9 kg 15 mc 0,15

MP SL00
left "S" element
elemento "S" sinistro

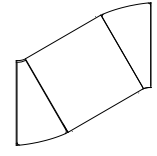
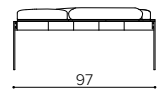

MP 1L00
side 1 seater module
elemento singolo terminale

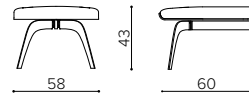

m 0,7 mq 1,4 kg 10 mc 0,15

MP 5P0S
square low bench
panca bassa quadrata

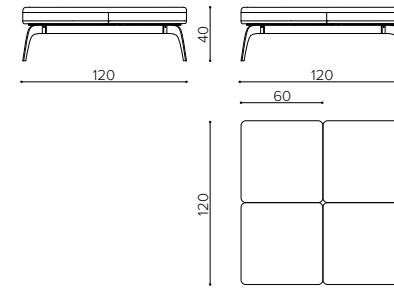

m 4,5 mq 8 kg 65 mc 0,57

MP 5P0R
circular low bench
panca bassa circolare

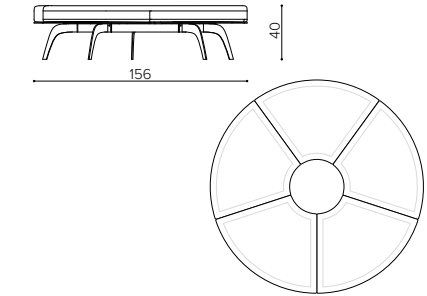

m 5 mq 8,5 kg 75 mc 1,5

MP 330W
3 seater backrest module
modulo schienale 3 posti

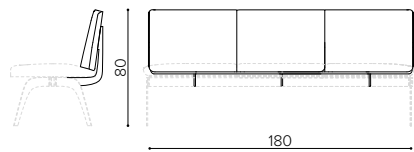

m 1,8 mq 3 kg 15 mc 0,2

Extra charge for custom color frame, < 10pcs
Sovrapprezzo per colore telaio personalizzato, < 10pz 55

Extra charge for custom color wooden seat support, < 10pcs
Sovrapprezzo per colore scocca personalizzato, < 10pz 48

MP 220W
2 seater backrest module
modulo schienale 2 postischienale 2 posti

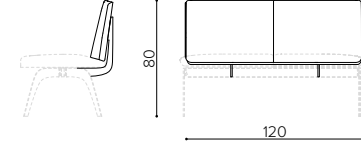

m 1,6 mq 2,7 kg 10 mc 0,15

Extra charge for custom color frame, < 10pcs
Sovrapprezzo per colore telaio personalizzato, < 10pz 47

Extra charge for custom color wooden seat support, < 10pcs
Sovrapprezzo per colore scocca personalizzato, < 10pz 42

BENCH TABLES / TAVOLINI PER PANCHE

	Ø30cm round table tavolo circolare Ø30cm	Ø40cm round table tavolo circolare Ø40cm	40x30cm rectangular table tavolo rettangolare 40x30cm
Bench side table Tavolo laterale panca	TL3R	TL4R	TLOR
Bench front table Tavolo frontale panca	TF3R	TF4R	TFOR
Circular bench inside table Tavolo interno panca circolare	TI3R	TI4R	TIOR
Circular bench outside table Tavolo esterno panca circolare	T03R	T04R	T0OR
Square bench outside table Tavolo esterno panca quadrata	TQ3R	TQ4R	TQOR

MP A000
corner element
elemento angolare

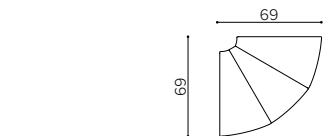
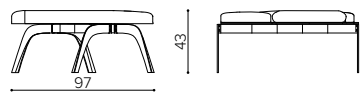

m 1,5 mq 2,9 kg 15 mc 0,2

MP BB00
armrest
bracciolo

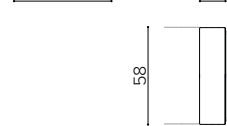
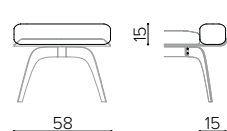

m 0,3 mq 0,55 kg 0,5 mc 0,05

MP TR01
single central table
tavolino centrale singolo

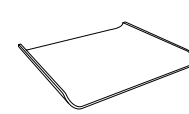
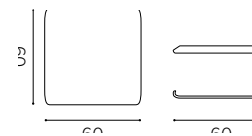

white lacquered MDF oak
MDF laccato bianco rovere

kg 1,0 mc 0,015

MP TR02
double central table
tavolino centrale doppio

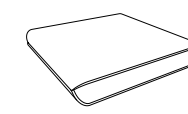
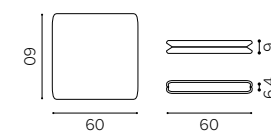

white lacquered MDF oak
MDF laccato bianco rovere

kg 2,0 mc 0,03

MP TRE2
double central table with power supply
tavolino centrale doppio con elettrificazione

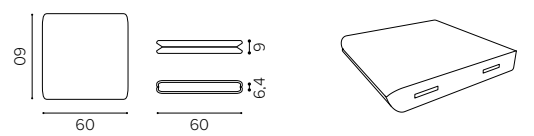

white lacquered MDF oak
MDF laccato bianco rovere

kg 2,0 mc 0,03

CONFIGURATION EXAMPLE 1

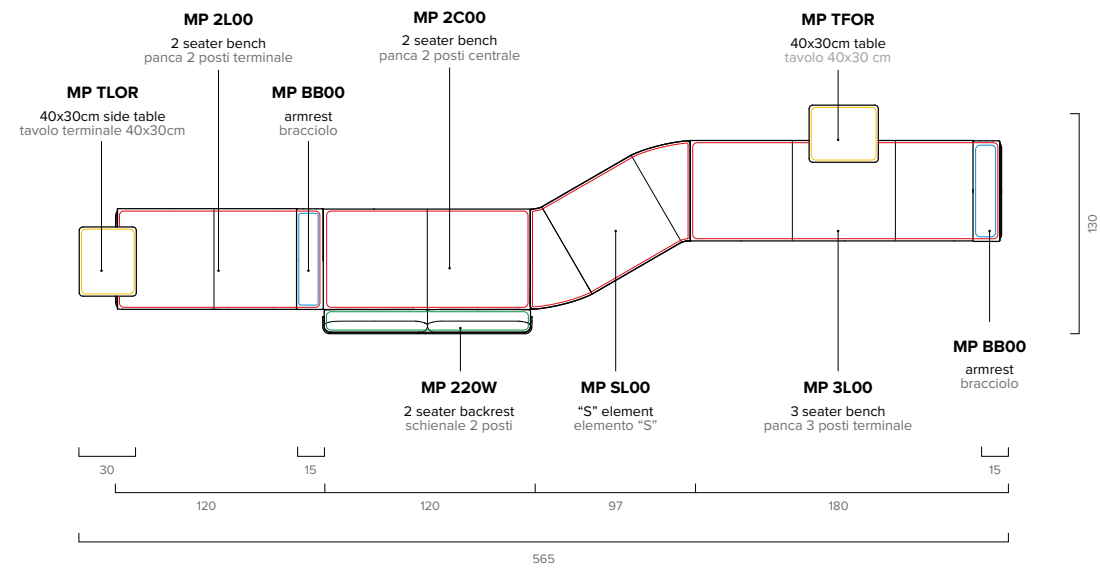

CONFIGURATION EXAMPLE 2

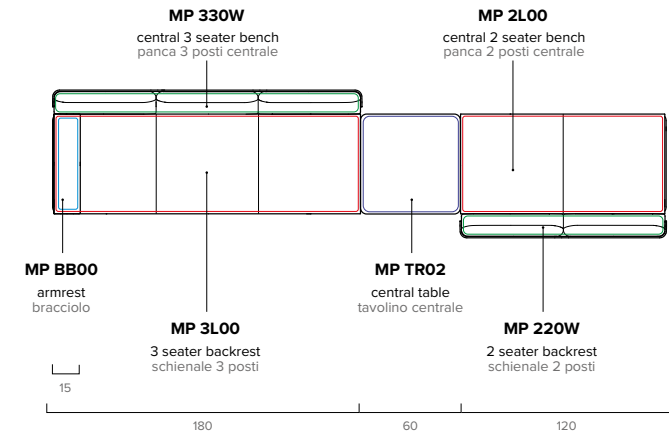

CONFIGURATION EXAMPLE 3

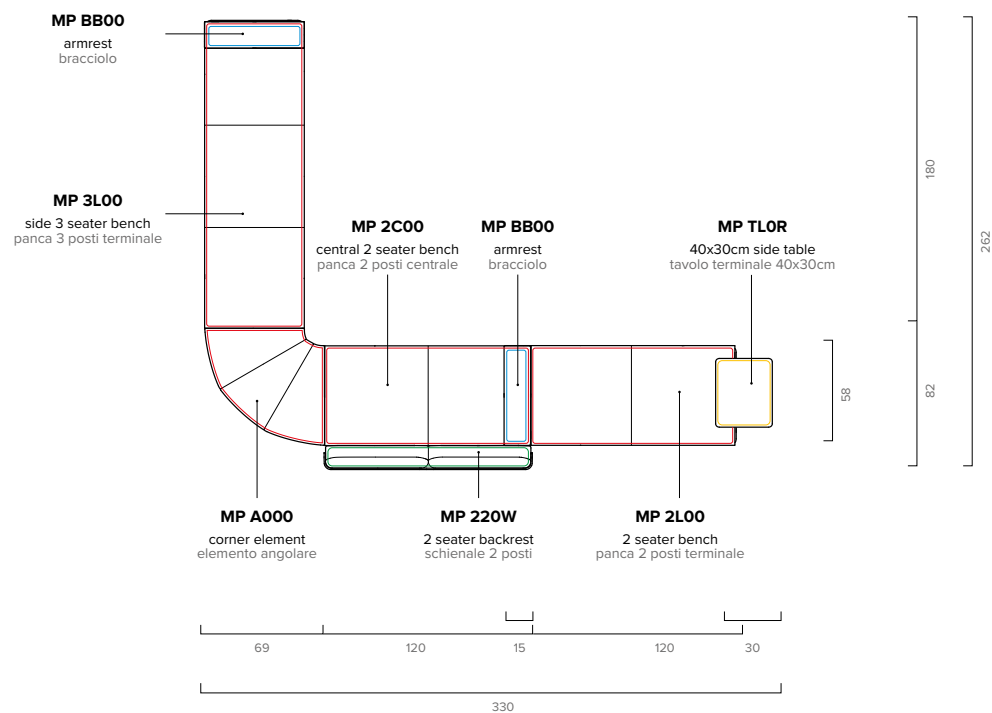

MILLEPIEDI COFFEE TABLES

Parisotto+Formenton



TECHNICAL FEATURES SPECIFICHE TECNICHE

Oakwood top, metal structure grey/black/white

Piano in rovere, struttura verniciata bianco/grigio/nero

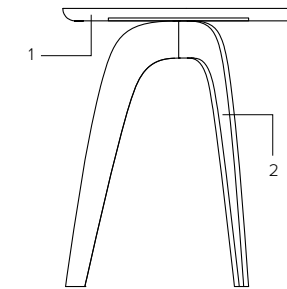

- 1 Oakwood top
Piano in rovere
- 2 Laser cut steel base
Base in acciaio tagliato a laser

COLORS AND MATERIALS COLORI E MATERIALI

STEEL / ACCIAIO



The standard finishings for the steel bases are the RAL shown above. Customized RAL/PANTONE colors are available upon request.

Le finiture standard delle basi in acciaio sono i RAL qui mostrati. Su richiesta sono disponibili colorazioni customizzate su altre tinte RAL/PANTONE.

WOOD / LEGNO



The standard finishing for the top is natural oakwood. Customized RAL/PANTONE colors are available upon request.

La finitura standard del piano in legno è il rovere naturale. Su richiesta sono disponibili colorazioni customizzate su altre tinte RAL/PANTONE.

MP TR00

low table
tavolino basso

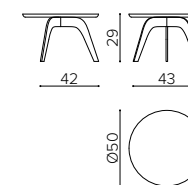

MP TR0L

medium table
tavolo medio

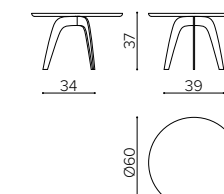

MP TR0H

high table
tavolo alto

