

E-QUO

Orlandini Design



TECHNICAL FEATURES SPECIFICHE TECNICHE

Multilayer beechwood bench installed on steel beam and legs, covered with solid ashwood.
Table top made of MDF covered with Ashwood veneer, solid wood edges, installed on a steel beam fixed to solid wood legs.

Panca in multistrato di faggio montato su trave e gambe in acciaio, coperte con frassino massello.
Piano del tavolo montato in MDF finitura frassino, bordi in massello, montato su trave in acciaio fissata a gambe in legno massello.

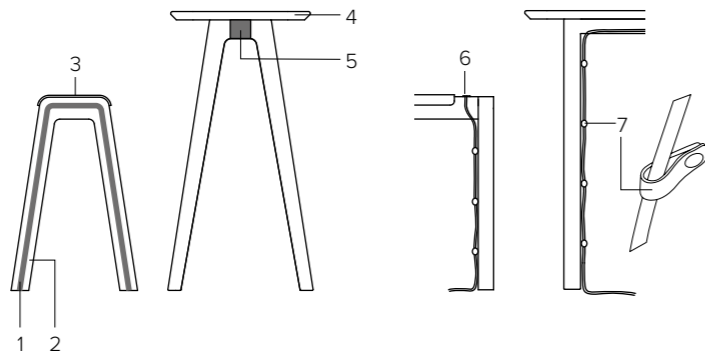

- 1 Inner steel frame
Struttura interna in acciaio
- 2 Solid wood legs
Gambe in legno massello
- 3 Padded cushion
Cuscino imbottito
- 4 Solid wood top
Piano in legno massello
- 5 Steel beam
Trave in acciaio
- 6 Power outlet
Presa di ricarica
- 7 Leather cable holder
Passacavi in pelle

COLORS AND MATERIALS COLORI E MATERIALI

WOOD / LEGNO



Standard finishing for wood is natural ashwood or natural oakwood.
Internal metal structure is painted black.

La finitura standard del legno è il frassino naturale o il rovere naturale. La struttura interna in metallo è verniciata nera.

EQ T095 table tavolo

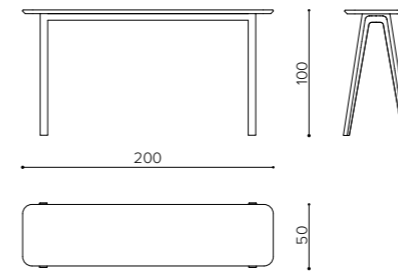

ashwood
frassino

oakwood
rovere

EQ 2200 bench panca

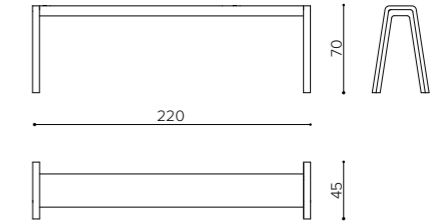

ashwood
frassino

oakwood
rovere

EQ 2203 bench with 3 fixed cushions panca con 3 cuscini fissi

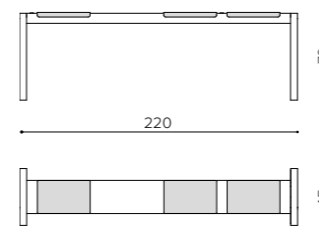

ashwood
frassino

oakwood
rovere

EQ 2204 bench with 4 fixed cushions panca con 4 cuscini fissi

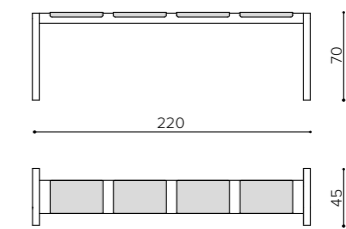

ashwood
frassino

oakwood
rovere

EQ PST1

2x usb + 1x schuko power outlet kit for table top, with 3mt wire
set prese ricarica 2x usb + 1x schuko per tavolo, con 3mt di cavo

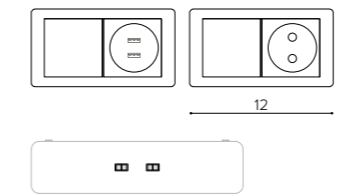

Extra charge for leather cable holders, 4 pcs
Sovrapprezzo passacavi in pelle, 4 pz



EQ PSB1

2x usb power outlets kit for bench, with 2,5mt wire
2x set porte ricarica usb per panca, con 2,5mt di cavo

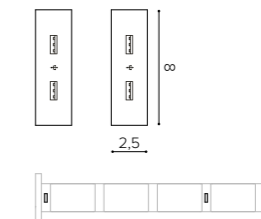

Extra charge for leather cable holders, 3 pcs
Sovrapprezzo passacavi in pelle, 3 pz

